



T9328 USB Card Player



4 unabhängige USB Endlos-Player mit Summenausgang auf internen Lautsprecher.

Einstellbarer Regler Summeneingänge. Verstärkung -10dB ÷ +10dB via Trimmer einstellbare.

Testschalter zur - berprüfung der Player.

Mit dem entsprechenden GPI wird die Modulation auf den Lautsprecher geführt.

GPIO :

9pol. Female

Pin-1	Wiedergabe Player 1	GPI
Pin-5	Player 1 aktiv	GPO
Pin-2	Wiedergabe Player 1	GPI
Pin-6	Player 1 aktiv	GPO
Pin-3	Wiedergabe Player 1	GPI
Pin-7	Player 1 aktiv	GPO
Pin-4	Wiedergabe Player 1	GPI
Pin-8	Player 1 aktiv	GPO
Pin-9	GND	Bezug

Player :

Die MP3-Datei muss sich im Hauptverzeichnis des USB-Stick befinden.

Auf dem USB-Stick darf sich nur ein MP3-File befinden. Dieser wird Endlos abgespielt.

Product Information

This document contains information for a MMB product.
MMB GmbH reserves the right to modify this product without notice.
Copyright © AUDIO INTEGRATED UNITS MMB GmbH 2015 (All Rights Reserved)

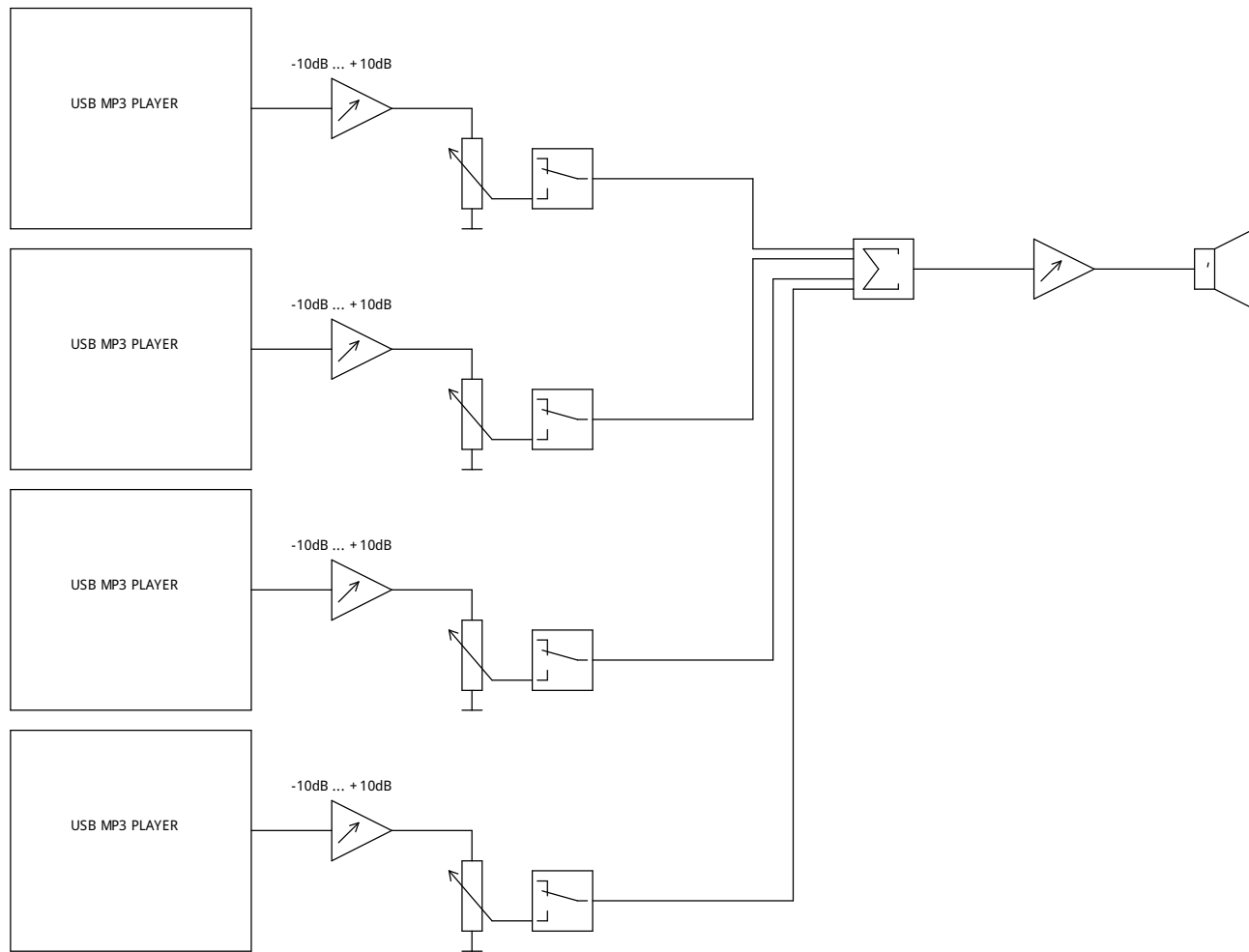

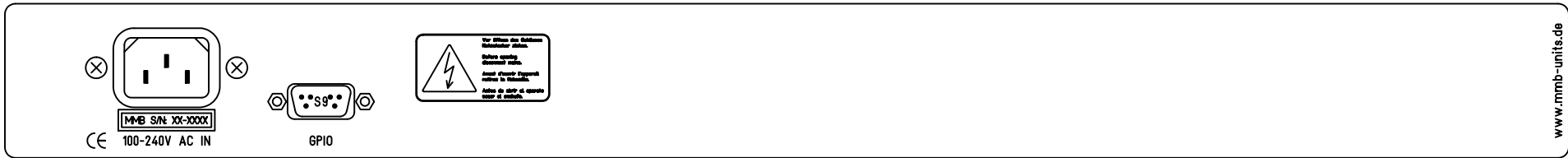
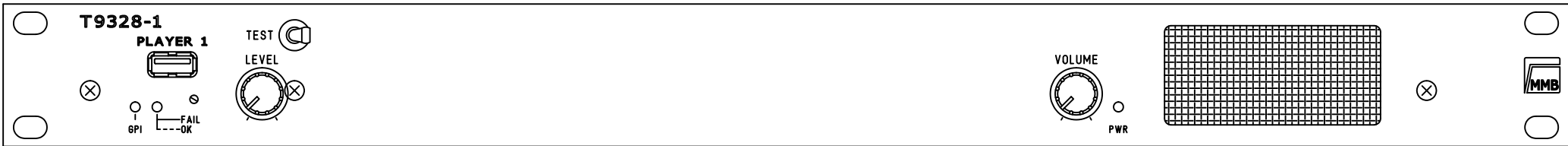
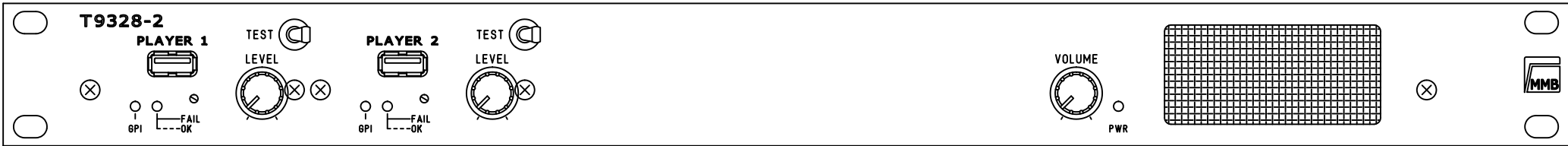
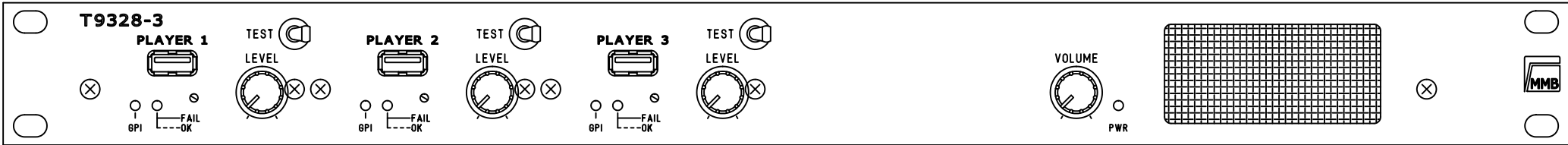
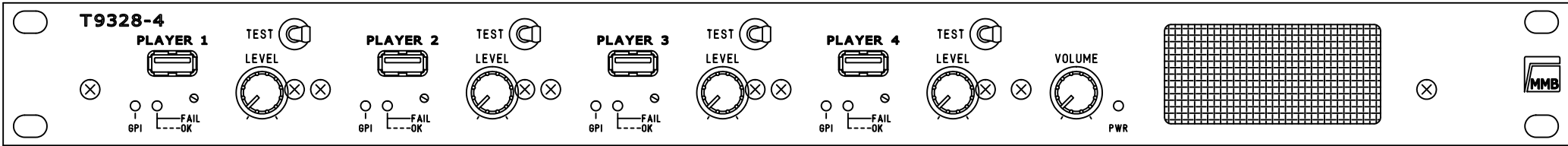

USB MP3 Player

Copyright © MMB GmbH 2016 (All Rights Reserved)
 MMB GmbH reserves the right to modify this product without notice

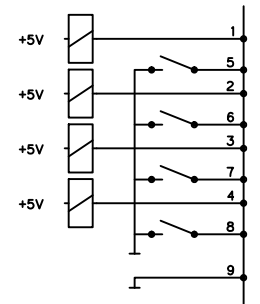

Tiefe 150mm



				Maßstab: 1:1.25	T9328 USB Card Player	
					Ansicht	
					Frd.-Zchnng.:	
					T9328 Ansicht	
Index	Datum	Name	Anderung			
Gez.	08.05.15	Guersan				
Erst.						
Gepr.						