



AUDIO INTEGRATED UNITS MMB GmbH

Kleine Twiete 72
D-25436 Uetersen
Fon +49(0)4122 9790321
Fax +49(0)4122 9790329
info@mmb-units.de

NGT8767 POWER SUPPLY UNIT WITH SNMP SUPPORT



PHYSICAL SPECIFICATIONS :

19"-1U 205mm (D) WEIGHT 3,0kg

PROPERTIES :

REDUNDANT POWER SUPPLY 2 x 350W PSU

PSU TYPES	NGT 8767-5V	60A	EACH PSU
	NGT 8767-12V	29,2A	EACH PSU
	NGT 8767-24V	14,6A	EACH PSU

OUTPUTS :

12 OUTPUTS VIA 4POLE XLR CONNECTORS

PIN'S 1,2 +OUT
 3,4 GND

DISPLAY :

STATUS VOLTAGE, TOTAL-CURRENT , CURRENT EACH OUTPUT
 TEMPERATURE
 CONFIG

FUSES :

POLY SWITCH / PTC	5V = 5A	CUSTOMIZING INQUIRE
	12V = 2,5A	CUSTOMIZING INQUIRE
	24V = 2,5A	CUSTOMIZING INQUIRE

PROTOCOL

SNMP

Product Information

This document contains information for a MMB product.
MMB GmbH reserves the right to modify this product without notice.
Copyright © AUDIO INTEGRATED UNITS MMB GmbH 2020 (All Rights Reserved)

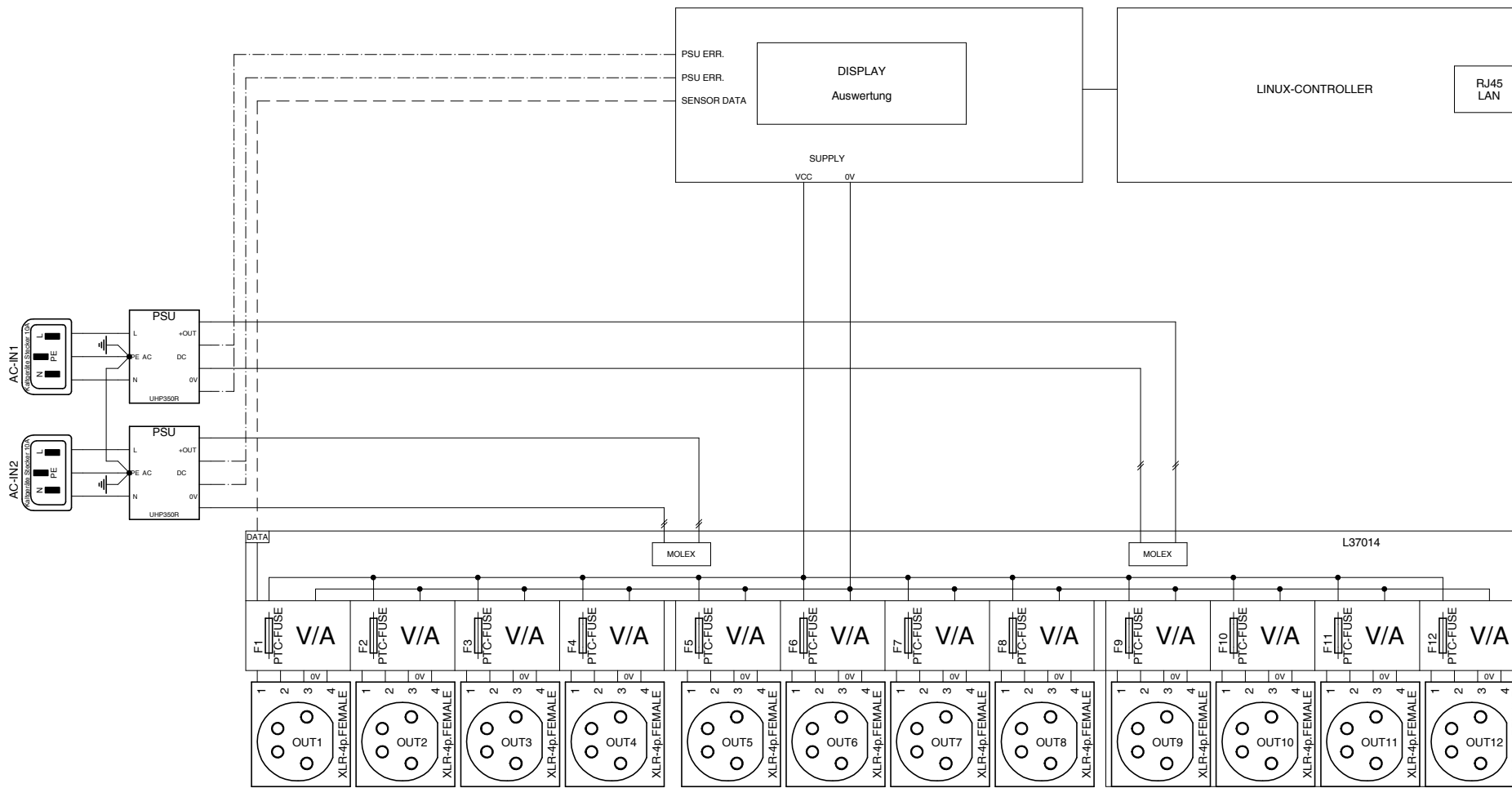

PTC-FUSE VALUES

- 5V = 5A
- 12V = 2,5A
- 24V = 2,5A



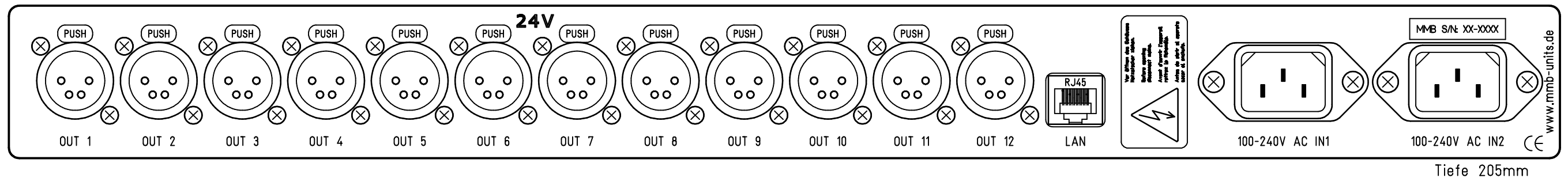
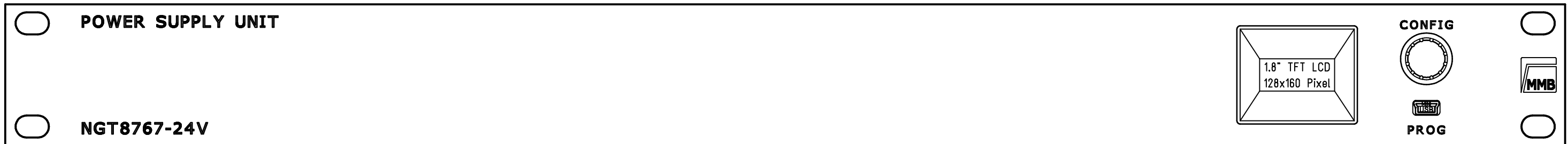

! auf passiven Lüftungsausritt (oben/unten) ist beim Einbau zu achten !

				Maßstab: 1:1.25	NGT8767-24V POWER SUPPLY UNIT	
					Ansicht	
					Früher-Zeichung:	
					NGT8767-24V Ansicht	
Index	Datum	Name	Änderung			
Gez.	25.09.19	Riedel				
Erst.						
Gepr.						

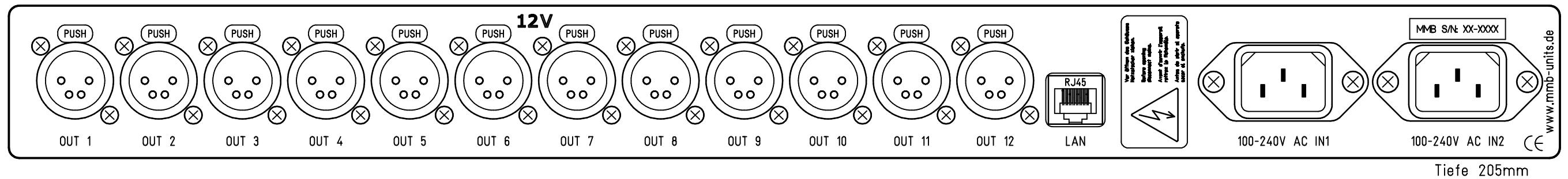

! auf passiven Lüftungsausritt (oben/unten) ist beim Einbau zu achten !

				Maßstab: 1:1.25	NGT8767-12V POWER SUPPLY UNIT	
				MMB	Ansicht	
					Früher-Zeichnung:	
					NGT8767-12V Ansicht	
Index	Datum	Name	Änderung			
Gez.	25.09.19	Riedel				
Erst.						
Gepr.						

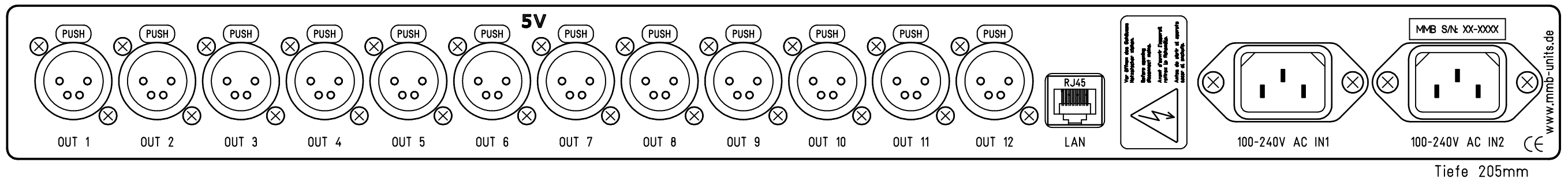
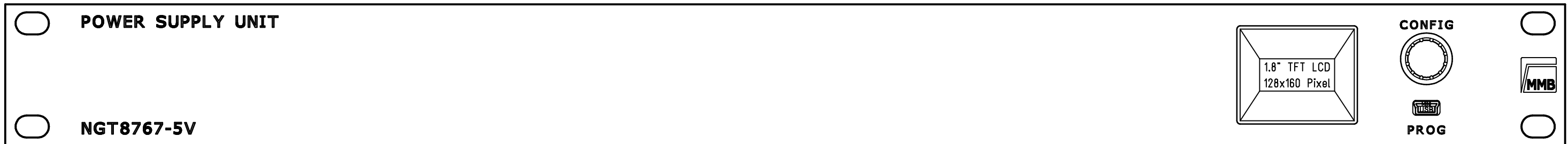

! auf passiven Lüftungsausritt (oben/unten) ist beim Einbau zu achten !

				Maßstab: 1:1.25	NGT8767-5V POWER SUPPLY UNIT	
					Ansicht	
					Früher-Zeichnung:	
					NGT8767-5V Ansicht	
Index	Datum	Name	Änderung			
Gez.	25.09.19	Riedel				
Erst.						
Gepr.						